

MAURO

2007 JAN TE LINTELO



DESIGN INSPIRATION

'Mauro' is like a cat, stretching itself in the morning sun: long, low, elegant, and completely relaxed, totally at ease with itself and the world. No wonder that, ever since its inception, 'Mauro' has been one of LINTELOO's best-sellers.

The various elements in this series—which also includes an armchair, longchair and dormeuse—offer a wide variety of seating arrangements.



SHOWN MODEL IS EXECUTED IN FABRIC MONZA 2

DESIGNED BY JAN TE LINTELO

Jan te Lintelo was born on 6 January, 1954, into a family of furniture retailers in Haaksbergen, in the eastern part of the Netherlands. Growing up surrounded by beautiful furniture, Jan understood the skills and craftsmanship required from artisans and designers. He went on to study furniture manufacture in Rotterdam, where he not only honed his creative skills but also learned about the business-side of the furniture trade. Practice makes perfect though, so Jan first joined the sales department of renowned, cutting-edge Dutch furniture brand Pastoe and then the equally renowned high-end Gelderland furniture factory. In 1994, he felt ready to spread his wings and started his own company, LINTELOO. He put everything he had learned—especially from customers—into designing his first collection. And he must have done something right, because decades later, Jan's first-ever design, the 'Easy Living' sofa, continues to be one of LINTELOO's best-sellers. Famous designers from all over the world have since designed for LINTELOO. But Jan himself also continues putting pencil to paper, brimming with ideas. His design characteristic remains the same throughout: the ultimate combination of generous proportions, comfort and style, executed by the best craftsmen in the business.



SPECIFICATIONS

Body: Webbed wooden frame with polyurethane foam in varying densities for optimum support and comfort, wrapped in hypoallergenic polyester fibre, 100% cotton inner cover.

Coupling system: The elements in any configuration are joined together by a steel coupling system.

Legs: Black polyurethane

Seat cushions: Polyurethane foam core, wrapped in a 100% cotton duvet filled with goose down and feathers or hypoallergenic polyester fibre only.

Back cushions: Goose down and feathers with polyester fibre, or hypoallergenic polyester fibre only, 100% cotton inner cover.

Upholstery: Composition of fabrics depends on the customer's choice of upholstery. Leathers are either aniline or pigmented/sealed.

Origin: Hand made in Italy

OPTIONS

Legs: Standard height 4 cm (not visible), 6 or 8 cm available upon request.

Upholstery: Fabric: removable cushion covers, removable body cover, available in all fabrics from the LINTELOO collection.

Leather: removable cushion covers, fixed body cover, available in all leathers from the LINTELOO collection. Customers can opt to supply their own choice of upholstery fabric/leather. Please note: leather upholstery requires more (visible) seams than fabric upholstery. For an impression of LINTELOO's fabrics and leathers, see 'Materials' at linteloo.com

Cushions: Available with either goose down/feather or hypoallergenic fibre filling.

Special features: Full set of fabric replacement covers available at 50% of the current retail price of the piece of furniture. Leather replacement covers on request. For optimum versatility, both the longchair and dormeuse can also be ordered as 'stand-alone' pieces, which differ slightly from the modular longchair and dormeuse.

MAINTENANCE

All LINTELOO furniture has been made with love and care. Of course, we want you to enjoy it, for as long as possible. Proper maintenance will prolong its lifespan, which is why each piece of LINTELOO furniture comes with a maintenance instruction booklet, also available for download at linteloo.com. Detailed information on care and cleaning, including the recommended products, can also be found at linteloo-care.nl

Upholstery: Maintenance of the upholstery obviously depends on your choice of fabric or leather. As a rule of thumb, fabric upholstery—especially when removable—is easier to clean in case of spots and spills than leather. On the other hand, leather will handle regular wear and tear better, in a sense that the odd sign of use only adds to its character.

Cushions: Again, the level of maintenance depends on your choice of filling. Down/feather-filled cushions require regular plumping up and airing. But you may prefer the firmer seating experience and hypoallergenic qualities that a 100% polyester filling provides.

Legs: The occasional wipe-down with a damp cloth is all it takes.



WARRANTY

All LINTELOO sofas and chairs are backed by a 10-year warranty on the frame. Cushions, upholstery and all other LINTELOO products are backed by a 3-year warranty, with a depreciation of 1/3 each year. Please make sure you keep your invoice or receipt. Excluded from the warranty are:

- Regular wear and tear, damages and discolouration of upholstery (fabric and/or leather).
- Creasing, colour and structure variations and other irregularities, which are part of the natural characteristics of fabrics, leather and/or wood.
- Complaints regarding fabrics and/or leathers which are not part of the standard LINTELOO collection (specially supplied fabrics and/or leathers).
- Damages caused by improper use, inadequate or incorrect maintenance, or repairs carried out outside the scope of LINTELOO's responsibility. LINTELOO uses the Terms and Conditions of the Centrale Bond van Meubelfabrikanten, available at www.linteloo.com.

If you have any questions, please contact your LINTELOO dealer or LINTELOO's customer service department.



DIMENSIONS

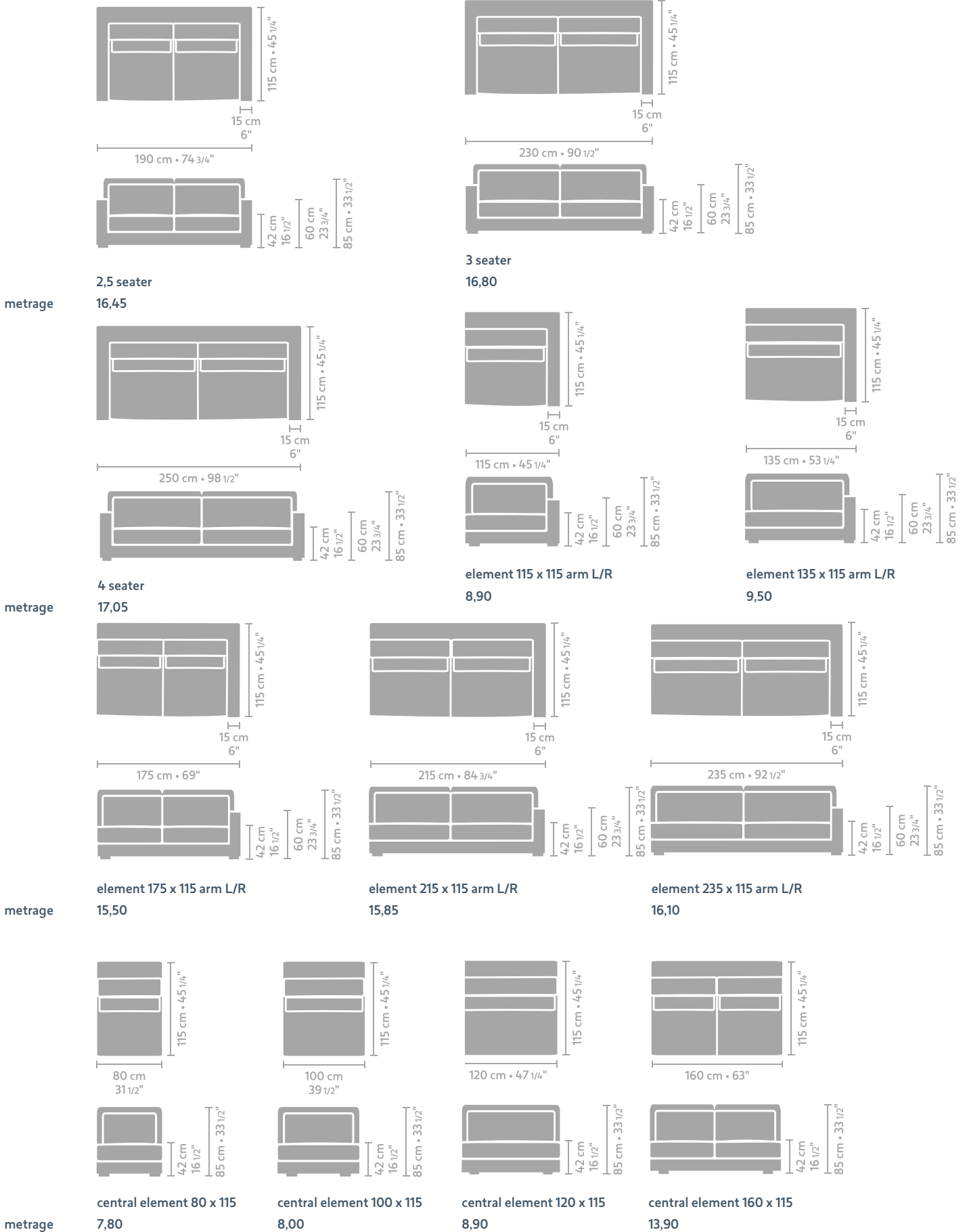

DIMENSIONS

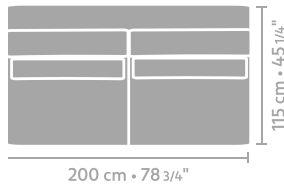

central element 200 x 115
metrage 14,65

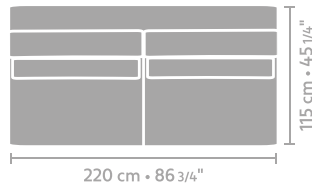

central element 220 x 115
metrage 15,15

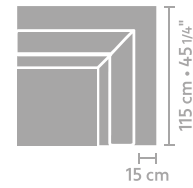

corner
metrage 11,45



longchair arm L/R
metrage 11,25



dormeuse arm L/R
metrage 17,80

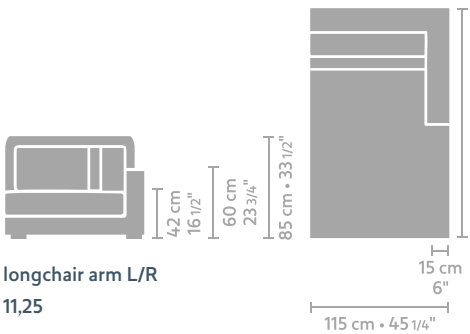

longchair arm L/R
metrage 11,25

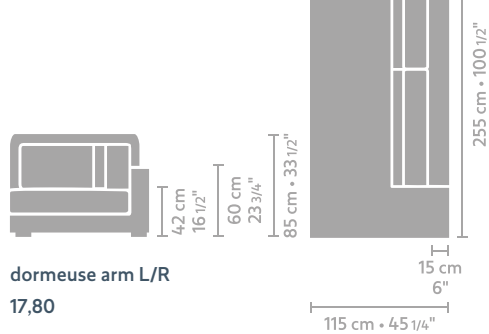

dormeuse arm L/R
metrage 17,80

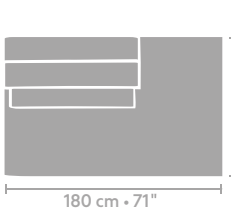

Mauro terminal element L/R 180 x 120
metrage 20,24

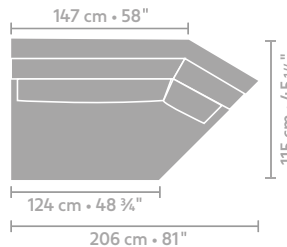

Mauro large corner angled L/R 206 x 115
metrage 27,39

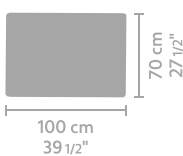

ottoman 100 x 70
metrage 3,75

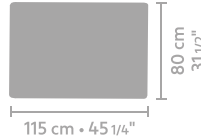

ottoman 115 x 100
metrage 4,75

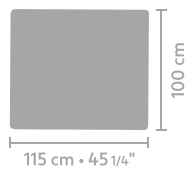

ottoman 115 x 80
metrage 4,65

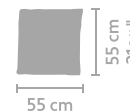

throw pillow
metrage 1,10

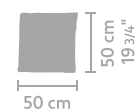

drop pillow
metrage 1,75

CONFIGURATION 1

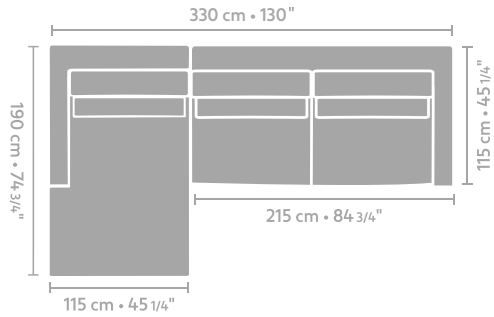

- Longchair arm L
- Element 215 x 115 arm R

CONFIGURATION 2

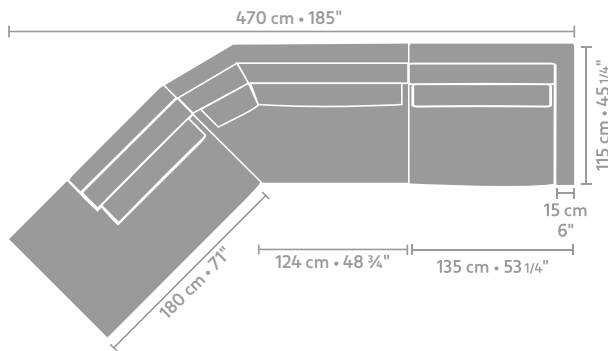

- Element 135 x 115 arm R
- Large corner angled L 206 x 115
- Terminal element L 180 x 120

CONFIGURATION 3

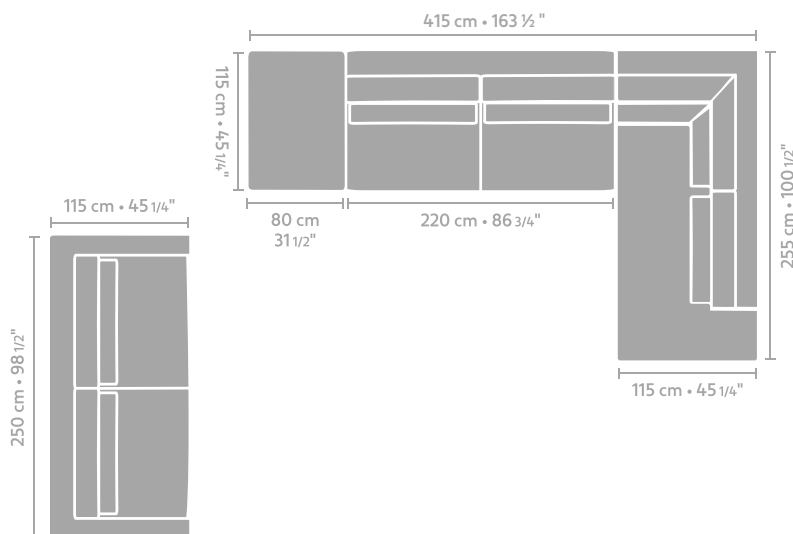

- 4 seater
- Ottoman 115 x 80
- Central element 220 x 115
- Dormeuse arm R