

# SERGIO

2009 MARCEL WOLTERINCK



---

## DESIGN INSPIRATION

Beautiful, timeless but also utterly comfortable and practical—over the years we have come to expect nothing less from Marcel Wolterinck's furniture designs. The 'Sergio' sofa is an old favourite, reintroduced by Linteloo. Why? Well, why not? This is the perfect sofa, whether it be for laid-back family living or for the single's prerogative of uninterrupted Netflix marathons. Just sink back into those lovely cushions and let the world go by.



---

## DESIGNED BY MARCEL WOLTERINCK

When Marcel Wolterinck opened his flower shop in Laren, the Netherlands, in 1986, little did he know he would soon be one of the prominent representatives of modern Dutch design. His floral creations with their immediately recognizable 'Wolterinck signature', evolved into interior design projects around the world. It will come as no surprise that Marcel loves using wood and other natural materials, celebrating their unique variations in texture and colour. His designs are sophisticated yet utterly liveable, with a strong emphasis on a sense of warmth and comfort. Marcel loves the interplay between indoor and outdoor spaces: 'I enjoy design in which the outside and inside grow together and towards each other, overlapping and connecting.'



---

## SPECIFICATIONS

**Body:** Solid wooden frame, covered with polyurethane foam in varying densities for optimum support and comfort, wrapped in hypoallergenic polyester fibre, 100% cotton inner cover.

**Legs:** Bronzed metal.

**Seat cushions:** Polyurethane foam core, wrapped in a 100% cotton duvet filled with goose down and feather or hypoallergenic polyester fibre.

**Back cushions:** Goose down and feathers with polyester fibre, or hypoallergenic polyester fibre only, 100% cotton inner cover.

**Upholstery:** Composition of fabrics depends on the customer's choice of upholstery. Leathers are either aniline or pigmented/sealed.

**Origin:** Hand made in Italy.

---

## OPTIONS

**Upholstery:** Removable cushion covers, removable body cover, available in all fabrics and leathers from the LINTELOO collection. Customers can opt to supply their own choice of upholstery fabric/leather. Please note: leather upholstery requires more (visible) seams than fabric upholstery. For an impression of LINTELOO's fabrics and leathers, see 'Materials' at [Linteloo.com](https://www.linteloo.com)

**Cushions:** Available with either goose down/feather or hypoallergenic fibre filling. Please note: down/feather-filled cushions must be plumped up regularly. As seat cushions can be heavy, a combination of hypoallergenic fibre-filled seat cushions and down/feather-filled back cushions is increasingly popular. The fabric-upholstered cushions are reversible. For maximum visual impact, the set of smaller throw cushions can be upholstered in a different fabric, at no extra charge. A surcharge applies when opting for a different leather.

**Special features:** Full set of fabric replacement covers available at 50% of the current retail price of the piece of furniture. Leather replacement covers on request.

---

## MAINTENANCE

All LINTELOO furniture has been made with love and care. Of course, we want you to enjoy it, for as long as possible. Proper maintenance will prolong its lifespan, which is why each piece of LINTELOO furniture comes with a maintenance instruction booklet, also available for download at [linteloo.com](https://www.linteloo.com). Detailed information on care and cleaning, including the recommended products, can also be found at [linteloo-care.nl](https://www.linteloo-care.nl)

**Upholstery:** Maintenance of the upholstery obviously depends on your choice of fabric or leather. As a rule of thumb, fabric upholstery—especially when removable—is easier to clean in case of spots and spills than leather. On the other hand, leather will handle regular wear and tear better, in a sense that the odd sign of use only adds to its character.

**Cushions:** Again, the level of maintenance depends on your choice of filling. Down/feather-filled cushions require regular plumping up and airing. But you may prefer the firmer seating experience and hypoallergenic qualities that a 100% polyester filling provides.

**Legs:** The occasional wipe-down with a damp cloth is all it takes.



---

## WARRANTY

All LINTELOO sofas and chairs are backed by a 10-year warranty on the frame. Cushions, upholstery and all other LINTELOO products are backed by a 3-year warranty, with a depreciation of 1/3 each year. Please make sure you keep your invoice or receipt. Excluded from the warranty are:

- Regular wear and tear, damages and discolouration of upholstery (fabric and/or leather).
- Creasing, colour and structure variations and other irregularities, which are part of the natural characteristics of fabrics, leather and/or wood.
- Complaints regarding fabrics and/or leathers which are not part of the standard LINTELOO collection (specially supplied fabrics and/or leathers).
- Damages caused by improper use, inadequate or incorrect maintenance, or repairs carried out outside the scope of LINTELOO's responsibility. LINTELOO uses the Terms and Conditions of the Centrale Bond van Meubelfabrikanten, available at [www.linteloo.com](http://www.linteloo.com).

If you have any questions, please contact your LINTELOO dealer or LINTELOO's customer service department.



## DIMENSIONS

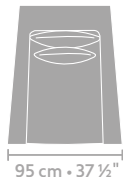

**armchair**

metrage (m) **7,70**

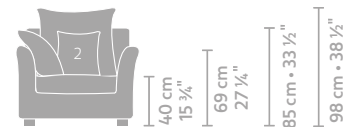
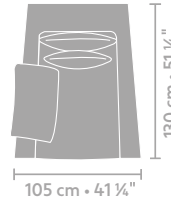

**big armchair**

metrage (m) **11,00**

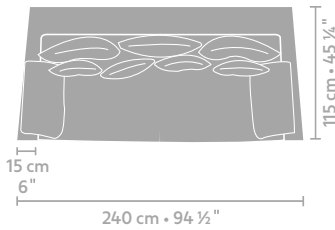

**3 seater**

metrage (m) **19,80**

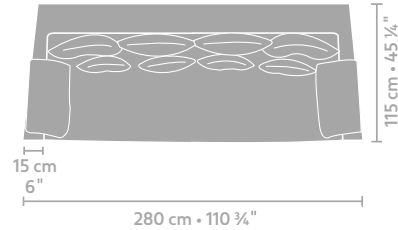

**4 seater**

metrage (m) **22,00**

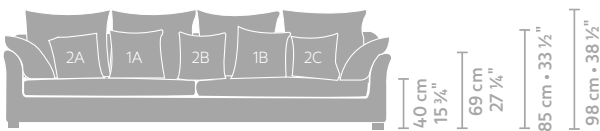
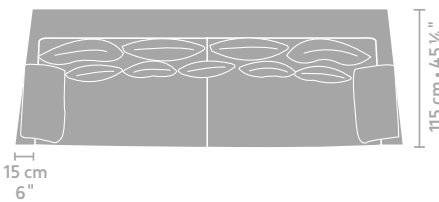

**5 seater**

metrage (m) **25,30**

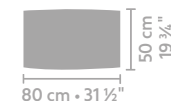

**ottoman 80 x 50**  
2,75

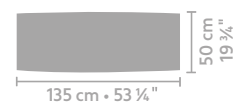

**ottoman 135 x 50**  
3,74

## CONFIGURATION 1

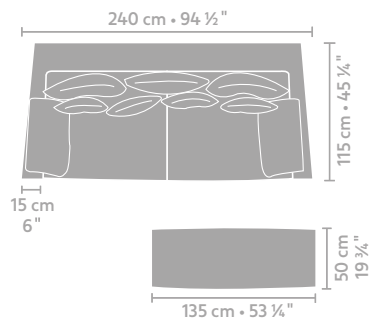

- 3 seater
- Ottoman 135x50

## CONFIGURATION 2

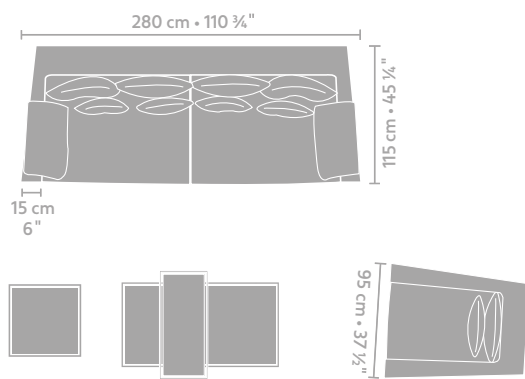

- 4 Seater
- Armchair
- Miles table 60x60
- Miles table 90x40
- Miles table 130x70

## CONFIGURATION 3

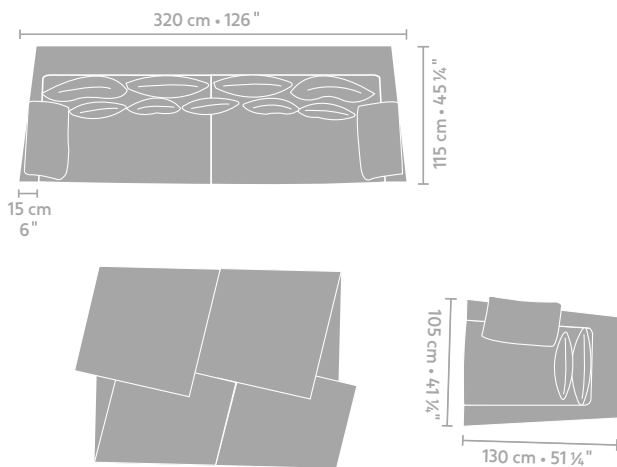

- 5 Seater
- Big armchair
- 2x San 160x100